

ASEPTIQUICK[®] Ly7g

••71

. ,†óS

R...760 pš3.1 bar
R...775 pš3.1 bá48>0PÓ

^ÛCsóS

1 10...8400

c, %ó óS

&ái1> ~úóSR...750 kGÿÿ>

vÛ7g>w> óS

3/463" IDÿPxE(20° 60.0 mē25.4 mm

S P#óS

%m' £ +•óS

ÔU...760 USP®~ã™j™™663CF

K fé/BóS

•ÔrU...760 /†jē3 +.4~ē03

USP®~ã™j™™663CF

=> &óS

q£fê;/ Pûé03ÈaiqÔisē3

USP®~ã™j™™663CF

„lós

Ô%64T+468

USP®~ã™j™™663CF



%/+*«[AseptiQuik[®] L Ly7g^a=DiS7U=)æê ůU]dæêl & iR67%Zn₃Eê
 ſÛÉSP±%žlyW4u 3/4" /• 1" %/+*«[™æ™Éwüis%×{!• -•líê3 3CEN£' 7dš >
 ...n₃°Š«ß«'...8R...&ý \Ly7g• SP403•9l ê3LÁ'u.ª@ n₃FNf\$êP±- 'HI -Ôx ůo*¾/•dN
 xERè vnoë% YÍFN žLyJ«RØ° 5 ° > •"n₃ & /ã/ã/õ/•BW4 'uCNæê3ÿl %ß7U•WÚl g.
 B0†jl & iR67n₃ªoçL 3/4" ...8l"]dæê)† PZT•>™Ñl g.+Û°S*«.†7U7U.†o) v

gEc¾

%/+*«[™æ™É

• SP403.

• ÝÛ È/ç1j ÈK îY

Oà' K féJp•x

CPCç1j6ý

Ožo)

PZ-n₃% YÍFN{!• -•líê3% %W- &•R.µl
 %ß%PvÛ

P±- .ž7>n₃qÖ&,-.ªÛ™É.ª@ FNf\$/•.ª
 æ7)FN

os•"n₃%)Zb³Û žLy itèê3' &ý3CEN£' 7dš
 J?> ...n₃°Š«ß

KéαN+ÔÛP•xη1 8¾@ &ý/α£&
 7)RðFNê3-qÛ'Û.ÏPÓ.\«Û%P%W,,lfé

j= i6ý- qÛ™j= *ç• "o

✓ "%ó3¾Dú ſl %ß-ç-ù'HI ê3PÁ4 ' %IFNf\$£\$,†n, % ...@
 sOGé vÁ3¾«"E -"©sO.Á%W{+-& /ãn, B0' †...3-ê3l%*
 %, «ç...3- v8CEZ_ê3†hL J?; Ly7gn, +.qÛÉÔ•Pê3G(/&h.É
 il° R»OÛj4 «"E -"n, &ú•P v

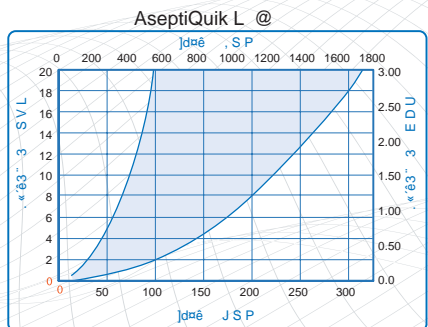

š™ç«Dpcworldwide.com.:12 400-9
 ~i.†*yoe & /ãohDáêBö•"SãJ"G(DÝ4 n

ASEPTIQ™ Ly7g

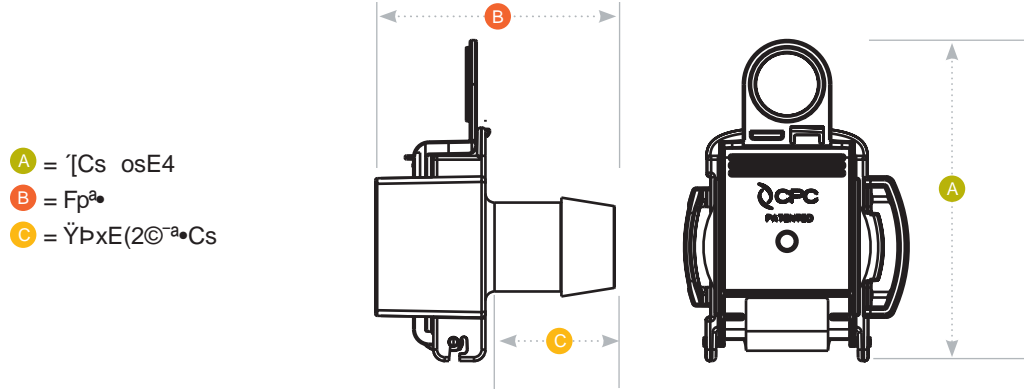

Ly7g Cu



• ÖUαα

vU7g
3/4" YpXE(20"4"
1" YpXE(20"4"

- & .R.μ
AQL17012
AQL17016

A
4.22
4.22

B
2.95
3.15

C
1.50
1.70

• YÛ-J}%*K îY“o£ÖtèCH

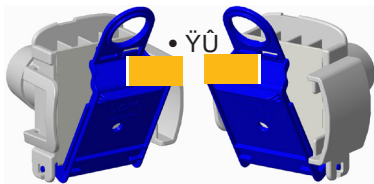

1

SDD7C .Ö%, • YÛ[ILy7g%*n,K féJp
•x v

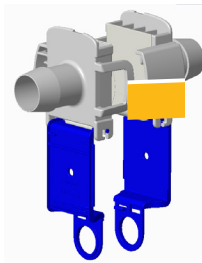

2

'HK féR,%,ê3 %P ILy7g> ¼Z v %P ILy
7gLE+Ö% œN v+•EKj. Ly7g['tê3s+Ö
p+Ö%6Ö CPC16v

6ÖJ}%*6Ö

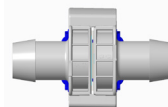
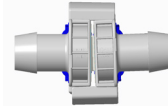

6ÖJ}%*6Ö

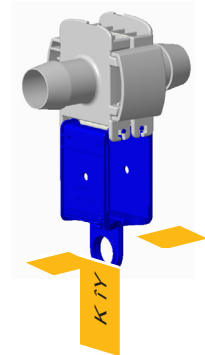

3

.c- Kv%, CPC EÁC &HLy7g%*K +f,„
6ÖK64%œN6ÖLyw

& 3>ÖF _i0-3Ö3p/ uUŠ>Ö, 8 â7 x E ^ 8Kö > ' *

*DUIH \$XWRPDWLRQ & RPS

: HLQVSEBQILGBWYHSRLRIRFRQQHFWLRQ

cpcworldwide.com/ContactUs

Ö66PR0-f&â4#1ER

Colder Products Company / äohDáJ? Ín, CPCn, R"ºPúsOK 'Ü R"™, 'Ü'öS Z ê3 •Á!(IG(DY4 n, +º 0-/• CPC=JR5E <> v

™?/469.%ß.Ät€.³f\$ñ,]d' &C)ö•NÉ' S &,n,%.lê3HI RÖ& /ä.³f\$&-> ...:Gé7>n.ñSxé3"ºö4-%/4 Colder, L]+Ü†...3-%†*D v J.R"ºd&'&O• qÜ=</j"™y& /ä> %ß¼CNI n, *Á=)FN vJ?R"™ºö°S<BCNI.
%-PZJÖK v

fIR6J?R"™ © 2019 COLDER PRODUCTS COLDER PRODUCTS COLDER PRODUCTS COLDER PRODUCTS COLDER PRODUCTS
Q1• € 3¼%+E/0-T >-Ü*Øn,0-T v

SPEC1055 2/2019 GLS30q+Y